



# Basketball Product Guide

The **One** - It's **Original** Concept and Your **Only** One



---

## INDEX

---

2	Introduction
3-4	Backstop Lineup
5-7	FIBA Approved Backstop
8-12	Other Backstop
13-14	Backboard / Ring
15	Luminous Frame / Shot Clock
16	Scoreboard
17	Foul Indicator
18	Miscellaneous Goods
19	Electric System Connection

---

# The Best **Quality** for Your Best Performance

Senoh's Basketball Expertise is cultivated from its history since 1955

Senoh's basketball equipment is all made in Japan.

Various sized backstops with the highest standards are available and the products lineup can fulfill a wide range of requirements for stadium, gymnasium, school, and park.

Senoh is proud of providing customers with the best quality that are absolutely safe and have a long life.

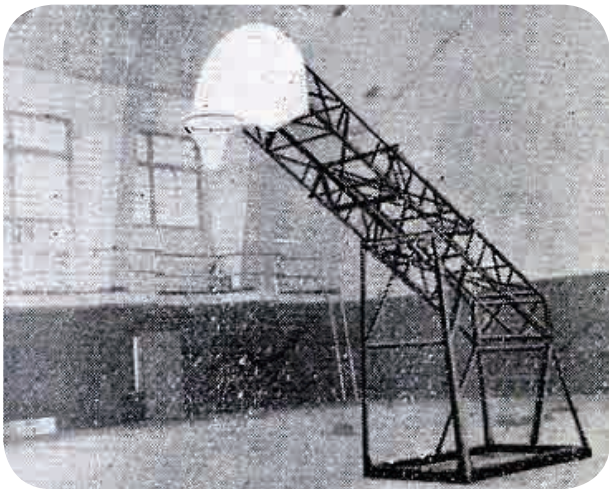

1955

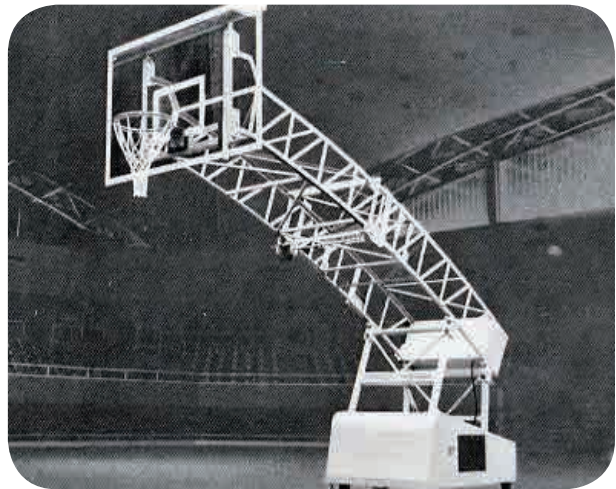

1962

Mexico Olympic Model



1982



2007

FIBA World Championship Model





# Backstop Lineup

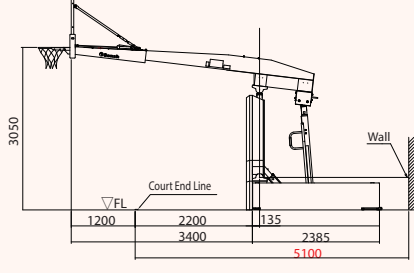

FIBA, the world governing body for basketball, is an independent association formed by 5 FIBA Zones and 213 National federations of basketball. Recognized as the competent authority in basketball by the International Olympic Committee (IOC).

Senoh has been the approved partner of FIBA for backboard support units since 1998.

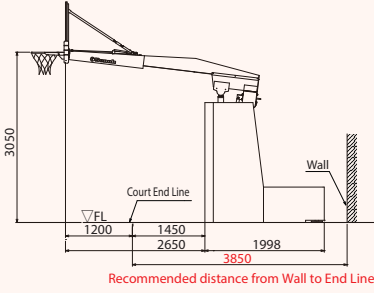
<b>Level 1</b> High Level Competitions	Main FIBA official competitions as Olympic Tournaments; World Championships for Men, Women, U-19 and U-17; Zone Championships for Men and Women.
<b>Level 2</b> Medium Level of Competitions	All other FIBA Official Competitions and high level competitions of the national federations
<b>Level 3</b> Other competitions	All other competitions not included in the above.

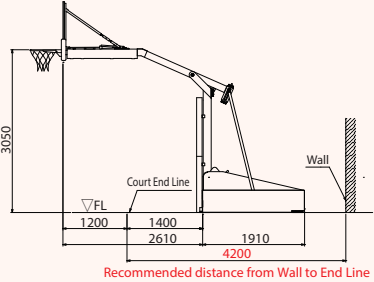
<b>DA096101 S-GOAL PRO</b>		<b>Electric Actuator Drive System</b>
		<ul style="list-style-type: none"> <li>• FIBA approved (Level 1 &amp; 2)</li> <li>• W1900 x L6405 x H3950mm (body 1447mm)</li> <li>• W1900 x L5300 x H1690mm (when folded)</li> <li>• Court line to the wall: 5100mm</li> </ul> <p>▶ See P.5</p>
<b>DA067503 Orange Goal</b>		<b>Electric Actuator Drive System</b>
		<ul style="list-style-type: none"> <li>• FIBA approved (Level 2)</li> <li>• W1900 x L5260 x H3950mm (body W1087mm)</li> <li>• W1900 x L4057 x H1870mm (when folded)</li> <li>• Court line to the wall: 3850mm</li> </ul> <p>▶ See P.6</p>
<b>DA033103 Spring Goal</b>		<b>Counter-weight spring drive system</b>
		<ul style="list-style-type: none"> <li>• FIBA approved (Level 2)</li> <li>• W1900 x L5130 x H3950mm (body W1110mm)</li> <li>• W1900 x L3835 x H1900mm (when folded)</li> <li>• Court line to the wall: 4200mm</li> </ul> <p>▶ See P.7</p>

## DA071103 Parallel Goal 21

### Electric Actuator Drive System

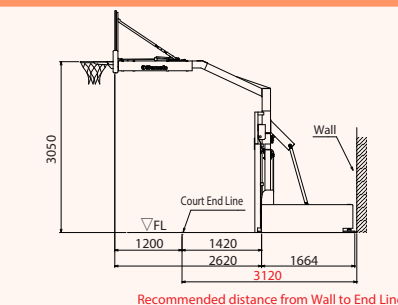

- W1900 x L4904 x H3950mm (body W1084mm)
- W1900 x L4005 x H1944mm (when folded)
- Court line to the wall: 3120mm

► See P.8

## DA086103 Parallel Goal

### Electric Actuator Drive System

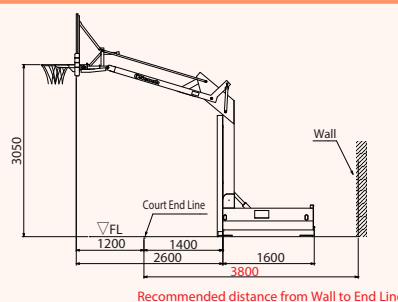

- W1900 x L4840 x H3950mm (body W1110mm)
- W1900 x L2912 x H2143mm (when folded)
- Court line to the wall: 3800mm

► See P.9

## DD070100 Spring Goal S

### Counter-weight spring drive system

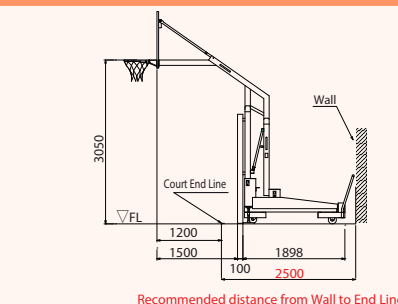

- W1900 x L6420 x H3950mm (body 1447mm)
- W1900 x L3086 x H1903mm (when folded)
- Court line to the wall: 2500mm

► See P.10

## DC09 Wall Mounted Goal (foldable type)

## DBXXXX Wall Mounted Goal (fixed type)

## DAXXXX Ceiling Suspended Goal



FIBA Approved (Level2)



► See P.12

► See P.12

► See P.12



<b>DA096101 S-GOAL PRO</b>
FIBA approved (Level 1 & 2)
Electric actuator drive system
Heavy duty steel frame construction
Clear reinforced glass made backboard with safety pads on lower edge
Orange enameled pressure-release rings with nets
Body protecting cushion padding
Available in mini-basketball height with setting gauge
With caster
H3950 x L6405 x W1900mm (body 1447mm) H1690 x L5300 x W1900mm (when folded)
AC100V 550VA (voltage adjusted as per request)

<b>DA090R11</b> Setting Gauge A type	<b>DA090R21</b> Setting Gauge B type
<b>DA090R31</b> Setting Gauge C type	<b>DA090R41</b> Setting Gauge D type



**DA067503**  
Backstop "Orange Goal"

FIBA approved ( Level 2 )

Electric actuator drive system

Heavy duty steel frame construction

Clear plastic made backboard with safety pads on lower edge

Orange enameled pressure-release rings with nets

Body protecting cushion padding

Available in mini-basketball height

With caster

H3950 x L5260 x W1900mm (body W1087mm)  
H1870 x L4057 x W1900mm (when folded)

AC100V 550VA (voltage adjusted as per request)

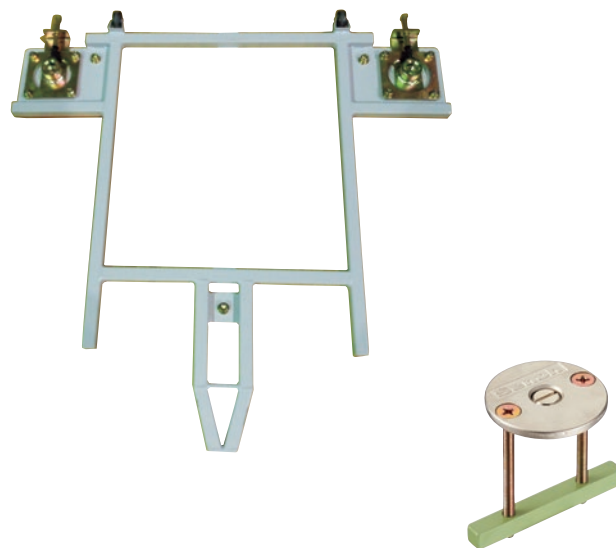

**DA060004** Setting Gauge for DA0665

W1140 x L950 x H45mm

A set of 2 pcs for 1 pair of backstop unit



<p>DA033103 Backstop "Spring Goal"</p>
<p>FIBA approved (Level 2)</p>
<p>Counter-weight spring drive system, manual type</p>
<p>Heavy duty steel frame construction</p>
<p>Clear plastic made backboard with safety pads on lower edge</p>
<p>Orange enameled pressure-release rings with nets</p>
<p>Body protecting cushion padding</p>
<p>Available in mini-basketball height</p>
<p>With caster</p>
<p>H3950 x L5130 x W1900mm (body W1110mm) H1900 x L3835 x W1900mm (when folded)</p>



<p>DA030002 Setting Gauge for DA0331</p>
<p>W110 x L480 x H70mm</p>

A set of 2 pcs for 1 pair of backstop unit

## Other Backstops

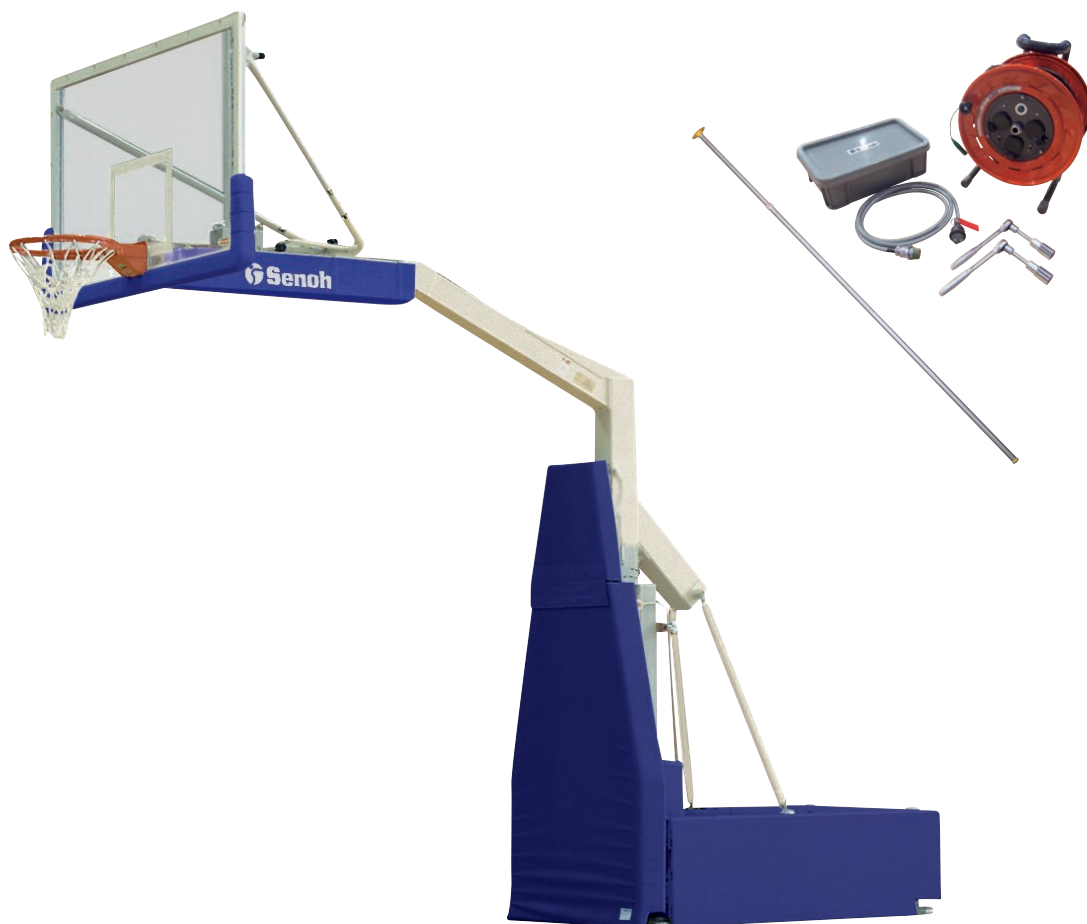

### DA071103 Backstop "Parallel Goal 21"

Electric actuator drive system

Heavy duty steel frame construction

Clear plastic made backboard with safety pads on lower edge

Orange enameled pressure-release rings with nets

Body protecting cushion padding

Available in mini-basketball height

With caster

H3950 x L4904x W1900mm (body W1084mm)  
H1944 x L4005 x W1900mm (when folded)

AC100V 550VA (voltage adjusted as per request)

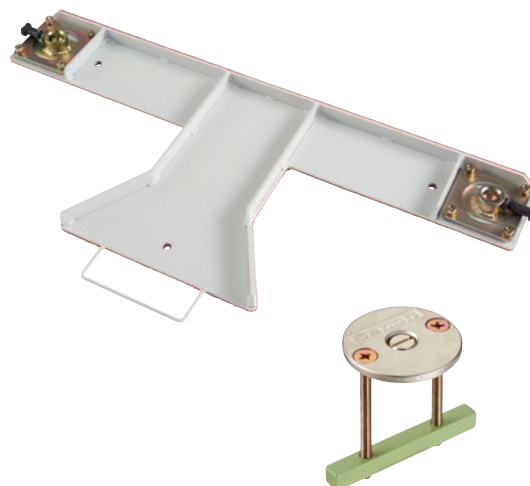

### DA070001 Setting Gauge for DA0711

W110 x L480 x H70mm

A set of 2 pcs for 1 pair of backstop unit



**DA086103**  
Backstop "Parallel Goal"

Electric actuator drive system

Heavy duty steel frame construction

Clear plastic made backboard with safety pads on lower edge

Orange enameled pressure-release rings with nets

Body protecting cushion padding

Available in mini-basketball height

With caster

H3950 x L4820 x W1900mm (body W1110mm)  
H2143 x L2912 x W1900mm (when folded)

AC100V 550VA (voltage adjusted as per request)



**DA080001** Setting Gauge for DA0841

W110 x L480 x H70mm

A set of 2 pcs for 1 pair of backstop unit



DD070100

Backstop "Spring Goal S"

Counter-weight spring drive system, manual type

Heavy duty steel frame construction

Clear plastic made backboard with safety pads on lower edge with ring and net

Body protecting cushion padding

With caster

H3950 x L4294 x W1900mm ( body W1060mm )

H1903 x L3086 x W1900mm ( when folded )

Court line to the wall : 2500mm

# CLS REGIONAL

Custom made Backstop unit

Various color and design with wide range of possibilities.





## DC09 Wall Mounted Goal

FIBA approved ( Level 2 )

Attached to the wall

Foldable by remote control or crank handle

Clear plastic made backboard with safety pads on lower edge

Orange enameled pressure-release rings with nets

Adjustable in both horizontal and vertical leveling

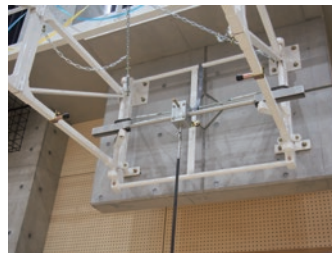

Manual operation by crank handle



Motor operation



Remote



Wall panel

## DBXXXXXX

### Wall Mounted Goal

Fixed to the wall



## DAXXXXXX

### Ceiling Suspended Goal

Hanged from ceiling

Remote control or manual chain system

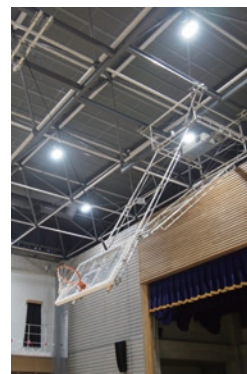

## Remarks ( Structure Requirement )

- Secure fixings to the overhead roof structure are required. Additional steel works may need to be incorporated during the construction of the building.
- All loadings to be approved by structure engineer.
- All wall fixings to be drawn upon the assumption that the walls are of a load base material unless otherwise informed.



**DA100S50 Glass Backboard**

For S-GOAL PRO

Reinforced glass made

Safety pad on lower edge

1800 x 1050mm



**DA090M14 Plastic Backboard**

For Orange Goal, Spring Goal, etc.

Clear plastic made

Safety pad on lower edge

1800 x 1050mm

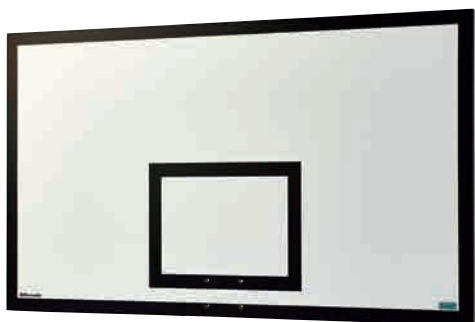

**DA100N71  
Honeycomb Flush Backboard**

Honeycomb flush board

1800 x 1050mm

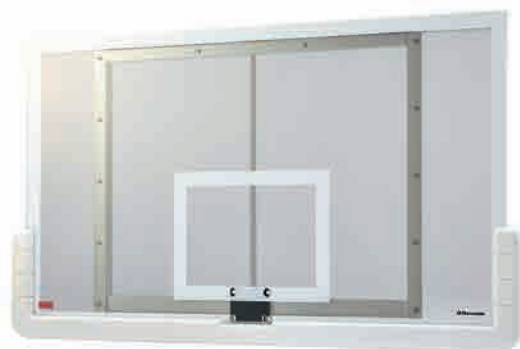

**DA100Q35 Plastic Backboard**

For Wall Mounted and Ceiling Suspended Goal

clear plastic made

1800 x 1050mm

# Ring net



DA100R23 Ring & Net

Pressure-release ring with net

Orange enameled

Internal Diameter : 450mm



DA950200 Ring net

Ring net

Polyester made

Knotless



DA100N74 Ring & Net

Fixed ring with net

Orange enameled

Internal Diameter : 450mm

For Wooden Backboard



DA100P43 Ring net

Ring net

Vynlon fiber made



DA100N75 Ring & Net

Fixed ring with net

Orange enameled

Internal Diameter : 450mm

For Plastic Backboard



DA950300 Ring net

Ring net

Polyester made

Made in Taiwan

# Luminous Frame / Shot Clock



DS453000 Luminous Frame ( for Plastic Backboard )  
DS454000 Luminous Frame ( for Glass Backboard )

Attached to behind of backboard

LED with diffusible acrylic panel

W33mm, total length 4987mm

Control board: W230 x D260 x F80mm

Power cord 2m x 1, signal cord 50m x 1, interlocking cord 2m x 1

AC100V 60W ( voltage adjusted as per request )

Interlocked with Shot clock( DS2873/DS2874 ) Available

\*Japanese market only

**NEW**



DS800000 Shot Clock with Game Clock ( for DA096101/DA067503 )  
DS810000 Shot Clock with Game Clock ( for DA033103 )

Shot clock switchable 12, 14 or 24 sec.

Game clock time max 99 min. 59 sec.

1/10 sec. is indicated for last 60 sec.

Buzzer and flash at time over

Power cord 1.8m x 2, signal cord 50m x 2

Display: W545 x T50 x H565mm

Control board: W260 x D215 x H110mm

AC100V 18W ( voltage adjusted as per request )

\*Japanese market only



DS346200 Shot Clock ( for DA096101/DA067503 )  
DS346100 Shot Clock ( for DA033103/DA071103 )  
DS338000 Shot Clock ( for DA086103 )

Shot clock switchable 12, 24 or 30 sec.

Power cord 3m x 1, signal cord 40m x 2

Display: W470 x T57 x H425mm

Control board: W150 x D200 x H85mm

AC100V 50W ( voltage adjusted as per request )

\*Japanese market only

**NEW**



DS401300 Shot Clock ( for DA096101/DA067503 )  
DS405300 Shot Clock ( for DA096101 )  
DS405400 Shot Clock ( for DA067503 )

Shot clock switchable 12, 14 or 24 sec.

1/10 of a second only during the last 5 seconds

Two units with double sided surface

Buzzer and flash at time over

Power cord 20m x 2, signal cord 40m x 2

Display : W700 x T80 x H780mm

Control board : W260 x D215 x H110mm, 3kg/unit

\*Japanese market only

# Scoreboard



<b>DS307000 Foul Indicator Stand</b>
Foul indicators for individual and team
With team foul indication lamp at top
Set of 2 indicators and 1 control board
LED 7-segment with 3 face-display
Power cord 20m x1, signal cord 10m x2
W800 x D800 x H1950 mm
Control board : W300 x D250 x H120mm
AC100V 200W (voltage adjusted as per request)

\*Japanese market only



<b>DS351100 Foul Indicators on Desk</b>
Foul indicators for individual and team
With team foul indication lamp at top
Set of 2 indicators and 1 control board
LED 7-segment with 3 face-display
Power cord 3m x 1, signal cord 2m x 2
Φ210 x H385 mm
Control board : W300 x D220 x H90mm
AC100V 120W (voltage adjusted as per request)

\*Japanese market only



<b>DS351000 Foul Indicators on Desk</b>
Foul indicators for individual and Team
With team foul indication lamp at top
Set of 2 indicators and 1 control board
LED 7-segment with 3 face-display
Power cord 3m x 1, signal cord 2m x 2
Φ210 x H420mm
Control board : W260 x D150 x H100mm
AC100V 100W (voltage adjusted as per request)

\*Japanese market only



<b>DS513000 Foul Indicator (for Individual)</b>
6 plates in box
Including No.1-4 : Black, No.5 : Red, and GD Markers
Box : W278 x D170 x H572mm
Polyvinyl made



<b>DS015100 Manual Scoreboard</b>
for Basketball and Volleyball
Back board for free writing
Set : 1-5, Score : 0-199
Water-proof score canvas H420 x W180mm
W1525 x D658 x H1805mm



<b>DS326000 Shot Clock Stand</b>
Power cord 20m x 2, signal cord 40m x 2
W650 x D555 x H1028mm
Display: W570 x T57 x H540mm
Control board: W150 x D200 x H85mm
AC100V 100W ( voltage adjusted as per request )

\*Japanese market only



**DS310001 Loud Sound Buzzer**

For competitions

Sound with 3 types of tones

Power cord 6.5m x 1, signal cord 2m x 1

W390 x D274 x H206mm

AC100V 150W (voltage adjusted as per request)

\* Japanese market only



**DS370001 Loud Sound Buzzer**

For school (education)

Sound with 3 types of tones

Power cord 6 m x 1 , signal cord 2m x 2 for each team

W290 x D260 x H130mm

AC100V 120W

\* Japanese market only

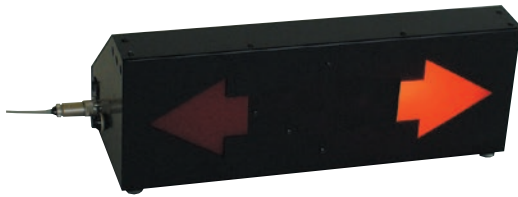

**DS460000 Alternating Possession Indicator**

W420 x D190 x H120mm

AC100V 8W (voltage adjusted as per request)

\* Japanese market only



**DS602000 Official Table**

W3024 x D711 x H850mm

DS4600 included



**DK061000 Ball Cage**

For 21 basket balls (42 volley balls)

L875 x D650 x H670mm

L875 x D650 x H125mm when folded

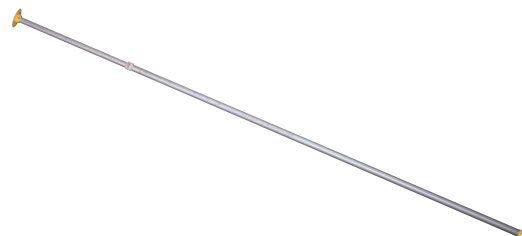

**DZ910100 Net Height Measurer**

Aluminum made

Measurement range 914-3050mm

**NEW**

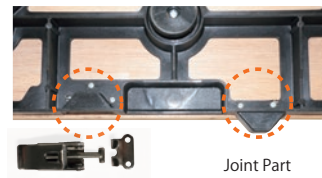

PORTABLE SPORTS FLOOR



<b>HJ020000 RADIAXION</b>
FIBA approved ( Level 1)
Portable Wooden Floor
Material : Birch
For 1 court : Full size : 2390 x 1198 x 212 panels Half size : 1195 x 1198 x 73mm x 20 panels
Good footing and uniformity to play with large laminated wooden flooring
Light weight due to the resin base panels
Easy to assemble and dismantle with Joint Parts

\* Japanese market only



**SENOH Corporation**

250 Matsuhidai, Matsudo-shi, Chiba 270-2214, Japan

TEL : 81-47-386-5807      Email : intl-1@senoh.co.jp

<http://www.senoh.jp>

---