

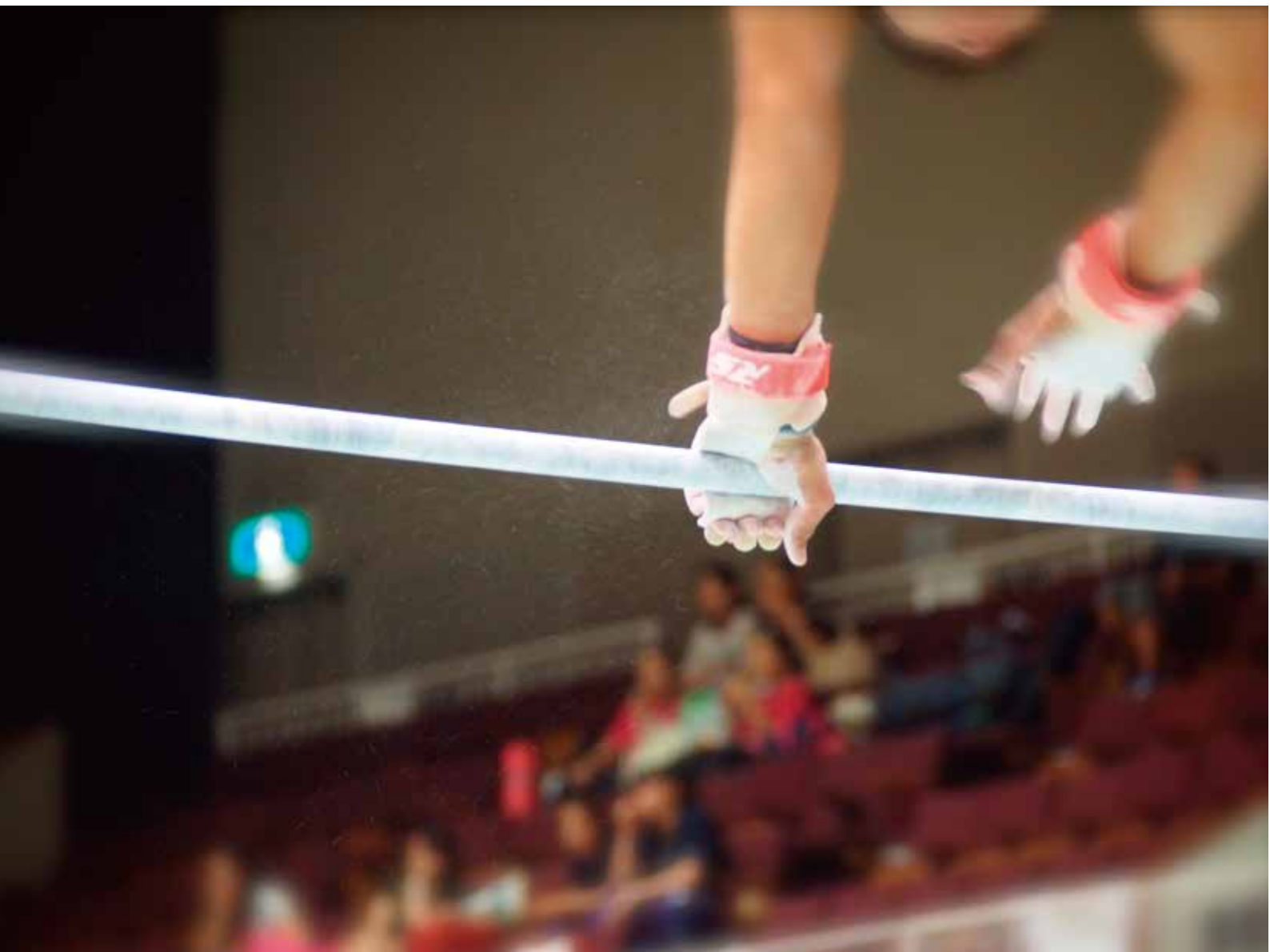

# Gymnastics Product Guide

The **One** - It's **Original** Concept and Your **Only** One



---

## INDEX

---

2	Introduction
3-15	Apparatus for Competition
16	Miscellaneous Items for Competition
17-21	Equipment for Training/Practice
22	Floor Apparatus & Transporter
23-24	Educational Model
25	Apparatus List for Competition
26	Rhythmic Gymnastics
27	Trampoline

---

# The Best **Quality** for Your Best Performance

Senoh's Gymnastics Expertise is cultivated from its history since 1948 and we are one of the long standing company approved by FIG.

From top competitions to school education, the products lineup with the highest standards can fulfill a wide range of requirements. Senoh is proud of providing customers with the best quality that is absolutely safe and has a long life.



1948



1979

FIG ART World Cup Series



2011



2011

FIG ART World Cup Series

# Apparatus for Competition



## AH043162 Official Spring Floor

FIG approved

Carpet face with Nylon tuft overlay, dividable into 3 and flatly interlocked by Velcro  
 TH14mm, L14.6 x W4.0m x 1pc, L14.6 x W5.3m x 2pcs

Middle cushion of EVA foam made, with high durability  
 TH40mm, L2.032 x W1.111m x 91pcs ( Interlock type )

Under cushion of low density foam made, with high durability, flexibility, and soft touch  
 TH20mm, L2.032 x W1.111m x 91pcs ( Interlock type )

Intensified elastic spring panel  
 TH128mm  
 L2.4 x W1.2m x 50pcs, L2.4 x W1.0m x 18pcs, L2.2 x W1.0m x 4pcs



Senoh's  
Technology

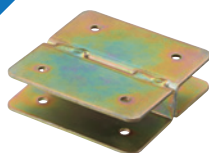

### Elastic panel joint

Easy to joint each panel by simply insert the panel into joint fitting and drop the joint pin to make the position.



### Fasten Mechanism

When panel positioning is set, tighten the fasten metal. Whole exercise area will be firm with no play between panels.

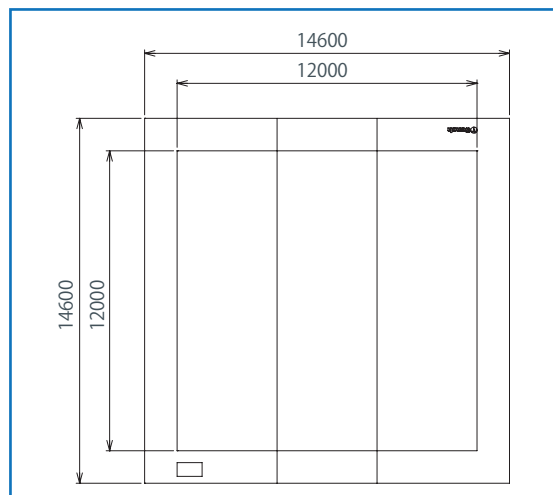



## Apparatus for Competition

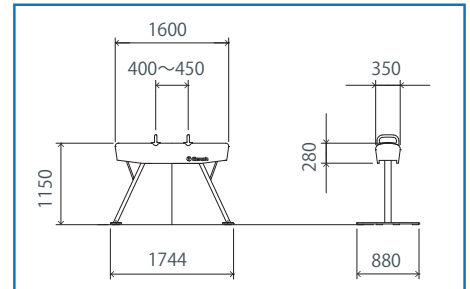

### AF021262 Official Pommel Horse

FIG approved

Covered with cowhide leather body

Detachable pommel of hygroscopic plastic made

Tension wire and turnbuckle lock

Height adjustable diagonal leg stand H1100-1400mm ( Increments of 50mm )

Body L1600 x W350mm

### ( Spare Parts )

AF020M41 : Pommel for spare ( sold in pair )

Senoh's  
Technology

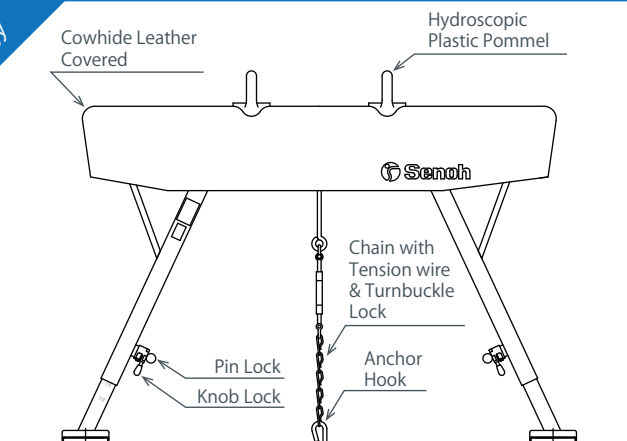

- Pommel is made in one molding
- Body provides the moderate elasticity by composition of wooden frame covered with sponge material and cowhide leather over-rolled.
- The height is adjusted in 50mm pitch with pin lock and fixed by knob lock to prevent from any play.
- Chain with tension wire and turnbuckle lock enable to secure the body to the ground and enhances the stability.

# Apparatus for Competition



## AB032062 Official Ring Frame with Hook

FIG approved

Φ76.3mm special steel tube frame constructions

Telescopic height adjustable 5650-5900mm  
( Increments of 50mm )

Equipped with one pair of official rings

Complete with rotating apparatus

φ6mm vinyl covered tension wire ropes,  
tester & turnbuckle locks

Ring: 28mm laminated wood, plastic resin injected  
( internal Φ185mm )

With 35mm width reinforced strap belt

Distance between two rotating apparatus: 500mm

## ( Spare Parts )

AB030M20 : Ring + Belt + Wire for spare  
( sold in pair )

AB030M55 : Tension wire ( sold in pair )



AB030M20  
Ring + Belt + Wire for Spare

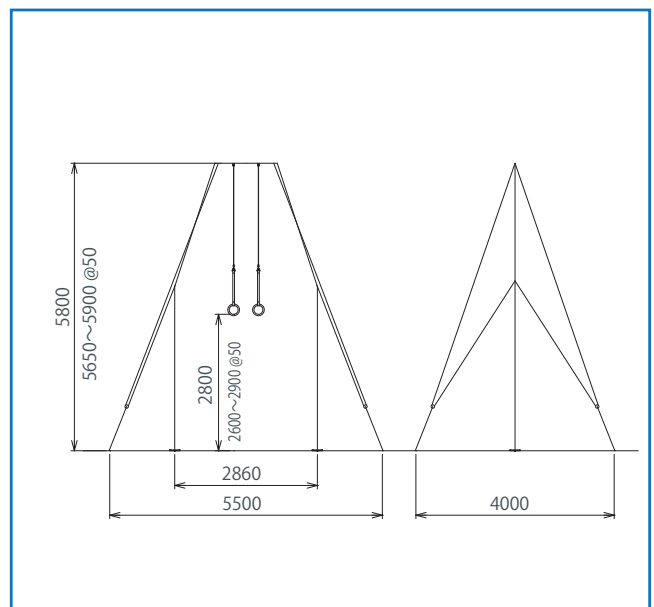
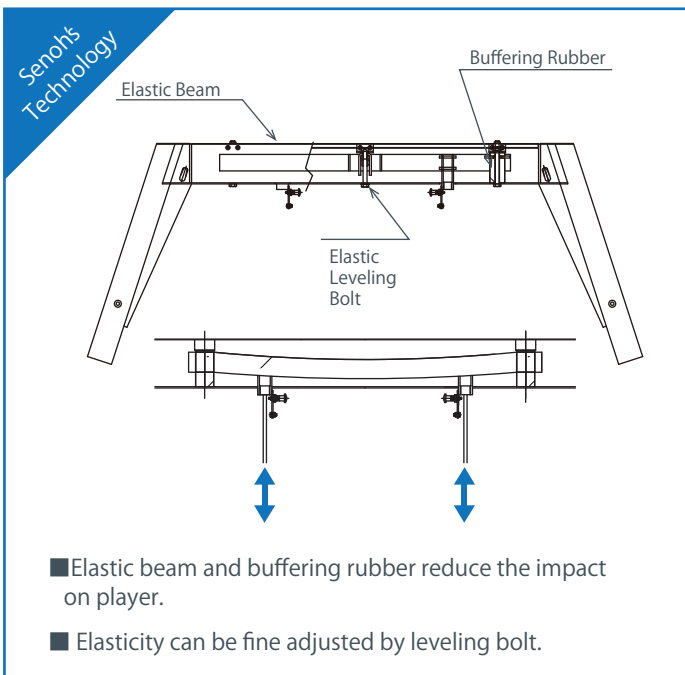

## AE0500 Official Vaulting Table

FIG approved

Fitted with special padding and uniformed cushion of elastic elements

Covered with synthetic leather body

With tension wire and turnbuckle lock

Height Adjustment: H1100-1400mm  
(Increments of 50mm)

Body: L1200 x W950mm

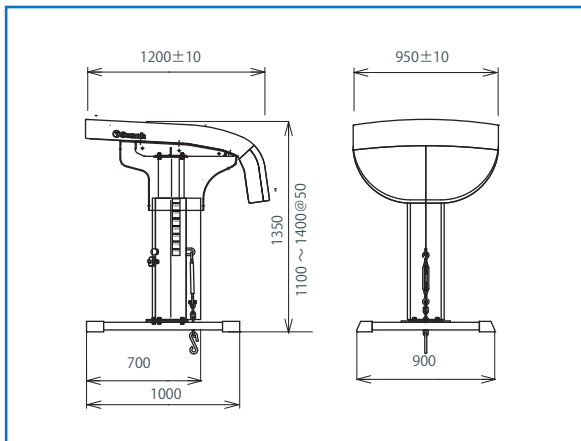

### IDEAL ELASTICITY

New structure design and moderate cushioned table covered by synthetic leather provide ideal elasticity and impact reduction.

### EASY OPERATION

The height is easily adjusted in 50mm pitch by knob lock to prevent from any play.

### EXCELLENT STABILITY

By connecting the anchor hook to the turnbuckle inside, body stability is enhanced.



※AE0500

# Apparatus for Competition

## AC0200 Official Parallel Bars

FIG approved

Heavy duty steel base construction

With double handle lock system

Height adjustable 1600-2000mm

Wooden laminated FRP bar

## ( Spare Parts )

AC010M63 : Bars for spare ( sold in pair )

AC015002 : Base adaptor ( set of 4 )  
required if floor apparatus is not used

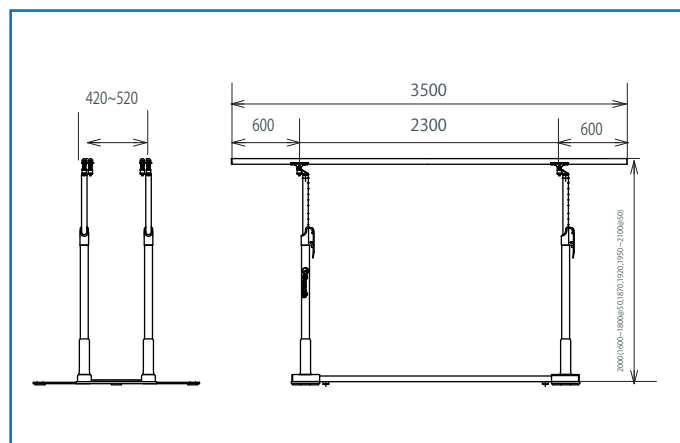

### IDEAL GRIP

FRP made bar with laminated wood cover increases strength, elasticity, and absorbency, and also helps to prevent slipping from the bar.

### EASY OPERATION

Double lock system with pin and handle enables easy and secure height adjustment.



AC015002 Base Adaptor

### EXCELLENT STABILITY

New structure design provides more stability.



# Apparatus for Competition

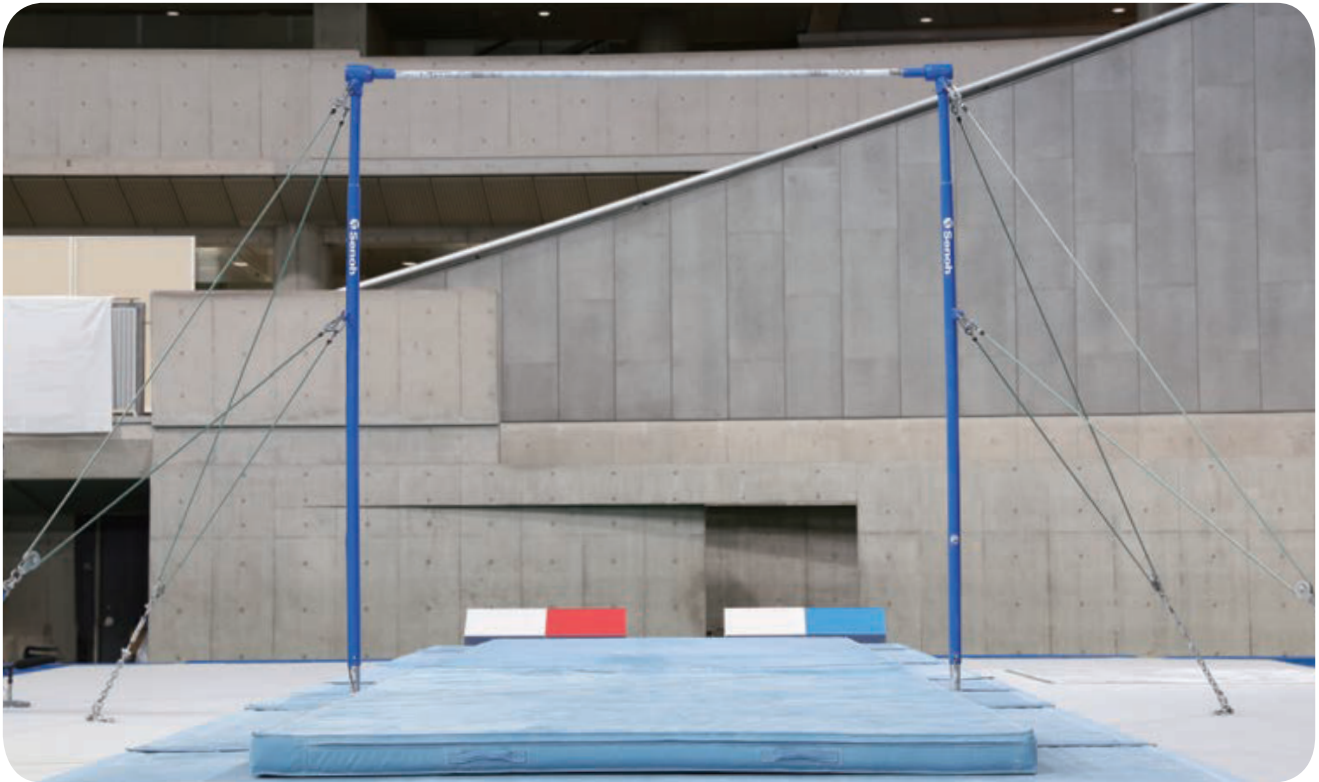

## AA052062 Official Horizontal Bar

FIG approved

Height adjustable 2600-2900mm  
(Increments of 50mm)

Bar with wire cord,  $\phi$  28mm Nickel chrome-molybdenum steel of L2400mm between pivots, X-ray inspected

End bar of free bounce universal pivot

Inner tube of Special steel, chromium plated

## ( Spare Parts )

AA050M46 : Tension wire for spare  
( sold in set )

AA050M55 : Bar for spare

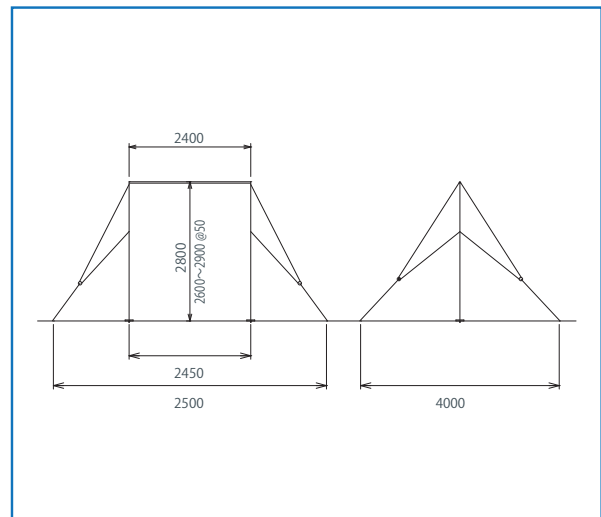

Senoh's  
Technology

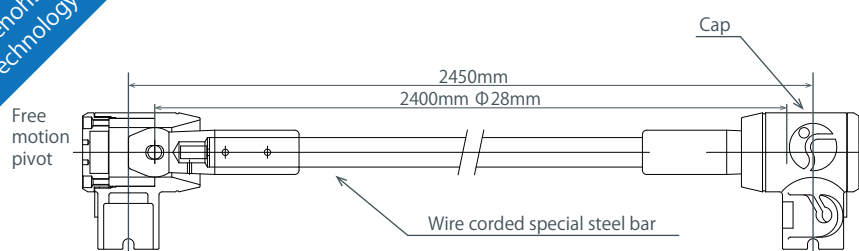

- Special made bar just only for Horizontal bar.
- Bar is wire corded and made by Chrome-nickel molybdenum steel.
- Adapts a free motion pivot to disperse the bar's bouncing in 360 degree.

# Apparatus for Competition

## AD0210 Official Uneven Bars

- FIG approved
- Heavy duty steel construction, complete with tension wire ropes
- Width adjuster, tension adjuster and turnbuckle lock
- Height adjustable  
2400-2650mm at upper bar, 1600-1850mm at lower bar
- Wooden laminated FRP bar in L2400mm between free bounce universal pivots

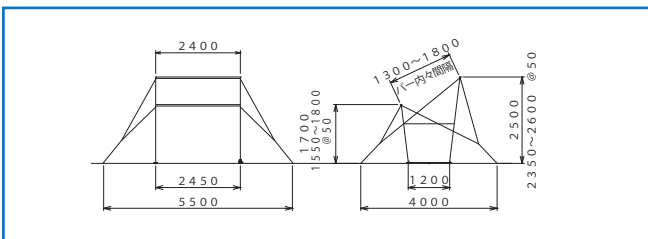

**IDEAL GRIP**  
FRP made bar with laminated wood cover to increases strength, elasticity, and absorbency, and also helps to prevent slipping from the bar.

**PERFECT REACTION**  
Adapts a free motion pivot to disperse the bar's bouncing in 360 degree.

**EASY OPERATION**  
The height is easily adjusted just by loosening tension cables and width adjusters.

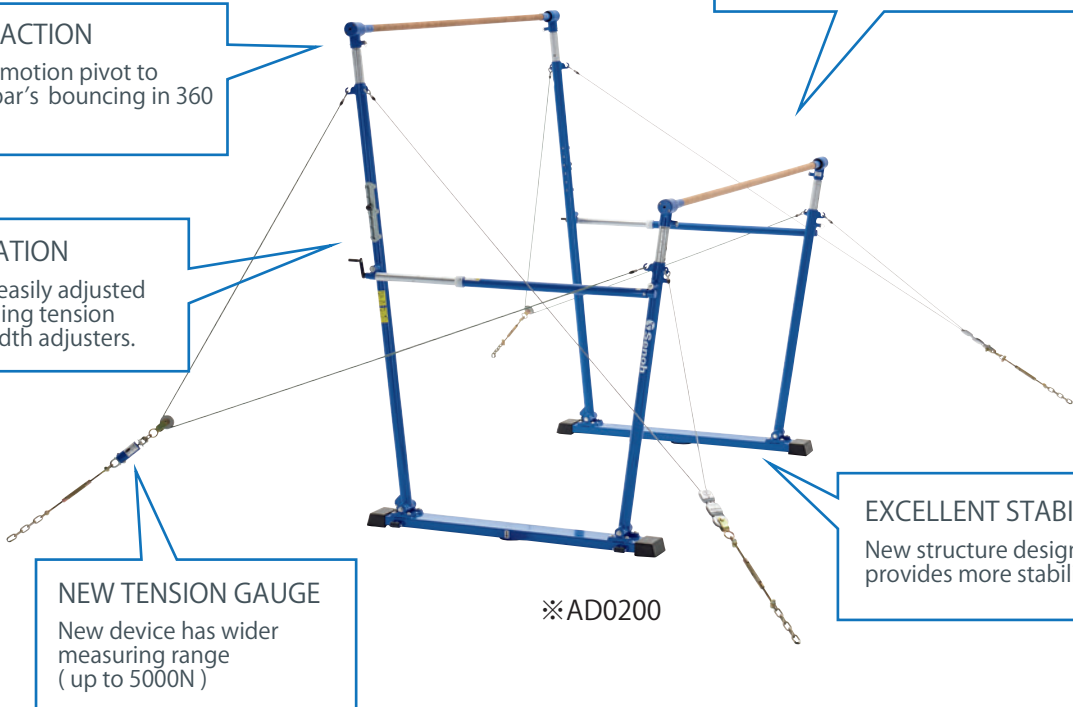

**NEW TENSION GAUGE**  
New device has wider measuring range (up to 5000N)

**EXCELLENT STABILITY**  
New structure design provides more stability.

※AD0200

## ( Spare Parts )

- AD020P01 : Bar for spare
- AD020P10 : Tension wire for spare ( sold in set )
- AD020P09 : Width adjuster ( sold in pair )
- AD2010 : Width measurer





**AG013162 Official Balance Beam**

FIG approved

Height adjustable 700-1250mm ( Increments of 50mm )

Beam L5000 x 100mm fitted with uniformed cushions in three layers under the synthetic leather cover and above the aluminum beam base with protection end cap

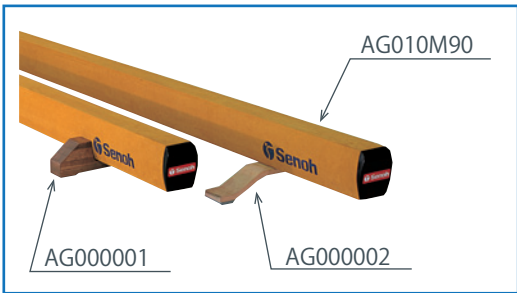

**( Spare Parts )**

AG010M90 : Beam for spare

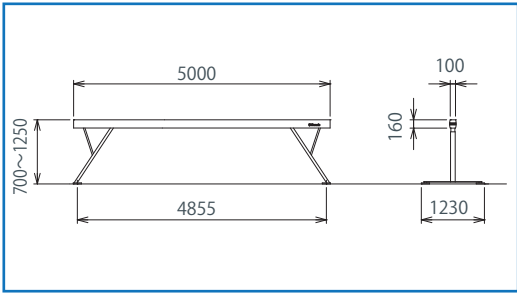

**Senohs Technology**

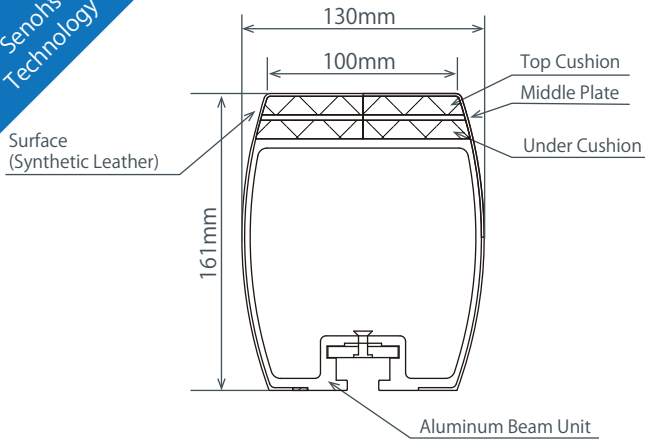

- 3 layers buffering mechanism. 2 different densities of cushions with a middle plate in between create the comfortable buffering effect while maintaining the moderate hardness on surface.
- Middle plate is in one unit without any joint, provides the homogeneity in cushion at any place on beam.
- Aluminum beam is covered by one high quality synthetic leather with the end caps attached on both the end of beam.



## AM70-76 , AM73 Official Landing Mat "EV"

FIG approved

Unique multiplex structure composed with EVA forms and multi-density urethane forms in high quality

Meets all requirements of mats in terms of its shock absorbcency, flexibility, landing stability, safety, and durability

Covered by non-slip material with the top of mats having all in one sheet with no joints

Having more in detachment strength, tear strength, pulling strength, wear resistance, and the cold-resistant performance

Senohs Technology

### What's good about EVA ?

Eco Friendly	Because EVA does not contain such chlorine as polyethylene does, EVA does not expose dioxin when burning it up.
High Elasticity	EVA is superior even in a low temperature. It is not tense at the cold temperature, and still maintains superior in elasticity.
Light weight	Specific gravity is small and is very light weight in comparison with vinyl chloride and the rubber.
Long durability	EVA is superior in the durability, and hard to deteriorate even in continue taking wind, rain, and ultraviolet rays.

### Multiplex structure of Landing Mat

Total of 200mm

FORM	Density	Thickness
EVA	Moderate	40mm
Urethane	High	80mm
Urethane	High	80mm

## AM7010 Official Landing Mat "EV" for Horizontal Bar

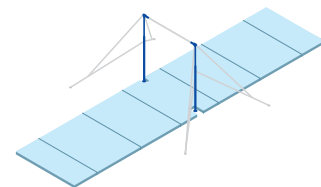
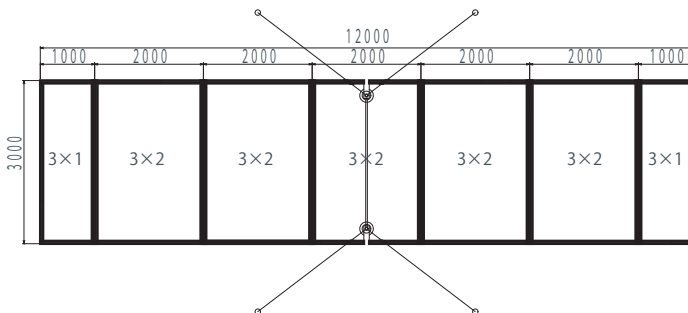

3000 x 2000 x TH200mm, 5pcs

3000 x 1000 x TH200mm, 2pc

## AM7110 Official Landing Mat "EV" for Rings

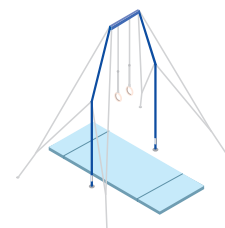
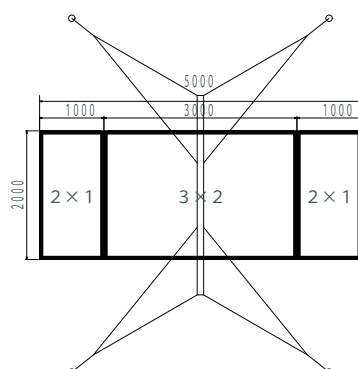

2000 x 3000 x TH200mm, 1pc

2000 x 1000 x TH200mm, 2pcs



## AM7220 Official Landing Mat "EV" for Vault

2500 x 2000 x TH200mm, 3pcs

1000 x 700 x TH200mm, 1pc

1000 x 500 x TH200mm, 1pc

※ Include basemnt cover for Vault

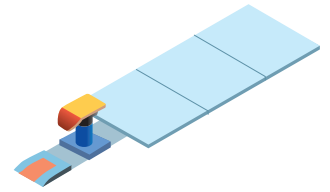
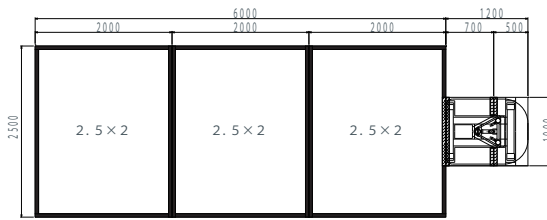

## AM7310 Official Landing Mat "EV" for Pommel Horse

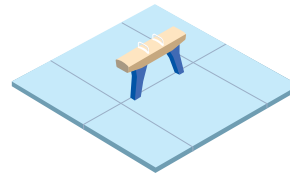
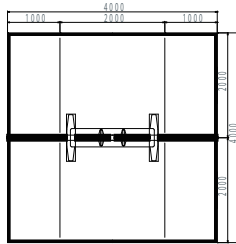

4000 x 2000 x TH100mm  
(3 fold type)

## AM7410 Official Landing Mat "EV" for Parallel Bars

2000 x 3000 x TH200mm, 2pcs

2000 x 2000 x TH200mm, 2pcs

2000 x 1000 x TH200mm, 5pcs

700 x 2550 x TH200mm, 1pc

700 x 1225 x TH200mm, 2pcs

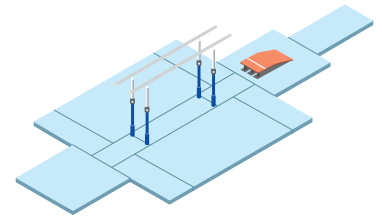
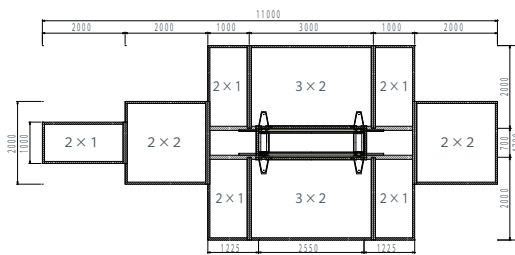

## AM7510 Official Landing Mat "EV" for Uneven Bars

3000 x 2000 x TH200mm, 4pcs

2000 x 2000 x TH200mm, 1pc

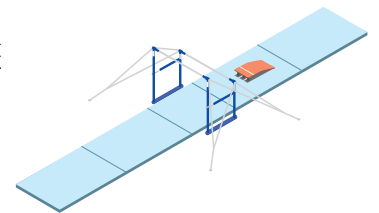
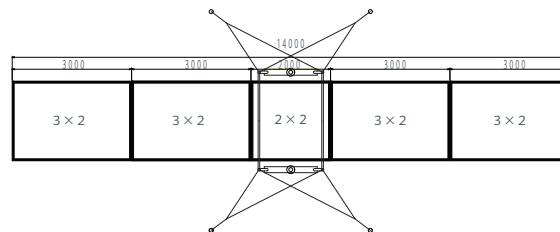

## AM7610 Official Landing Mat "EV" for Balance Beam

2000 x 5000 x TH200mm  
(2 fold type)

2000 x 3000 x TH200mm, 3pcs

2000 x 2000 x TH200mm, 1pc

1000 x 2000 x TH200mm, 1pc

1000 x 1000 x TH200mm, 4pcs

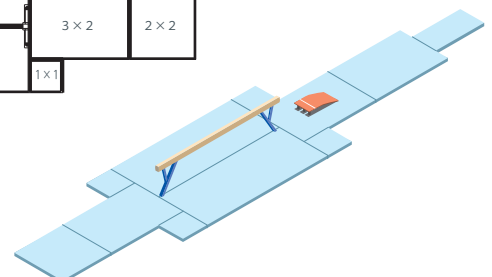
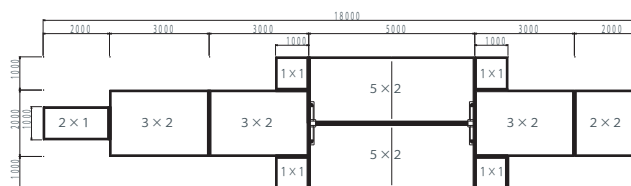



## AM50—56 Official Landing Mat "Over Mat"

FIG approved

Meets all requirements of mats in terms of its shock absorbency, flexibility, landing stability, safety, and durability

Unique multiplex structure composed with EVA forms and multi-density urethane forms in high quality

Covered by non-slip material with the top of mats having all in one sheet with no joints

Having more in detachment strength, tear strength, pulling strength, wear resistance, and the cold-resistant performance

Joints of over mats and under mats are not overlapped for high safety

Senoh's Technology

### What's good about EVA ?

Eco Friendly	Because EVA does not contain such chlorine as polyethylene does, EVA does not expose dioxin when burning it up.
High Elasticity	EVA is superior even in a low temperature. It is not tense at the cold temperature, and still maintains superior in elasticity.
Light weight	Specific gravity is small and is very light weight in comparison with vinyl chloride and the rubber.
Long durability	EVA is superior in the durability, and hard to deteriorate even in continue taking wind, rain, and ultraviolet rays.

### Multiplex structure of Landing Mat

Total of 200mm with 6 layers

FORM	Density	Thickness
EVA	Moderate	20mm
Urethane	High	30mm
EVA	High	10mm
Urethane	Moderate	50mm
Urethane	Low	50mm
Urethane	Moderate	40mm

## AM5060 Official Landing Mat for Horizontal Bars

7 over mat & 7 under mats

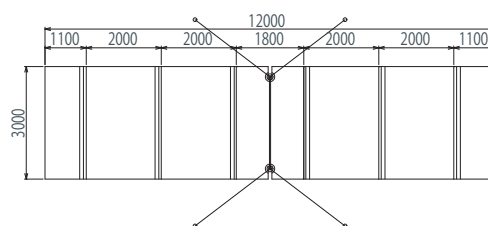
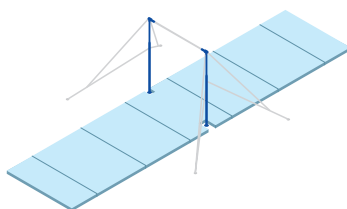
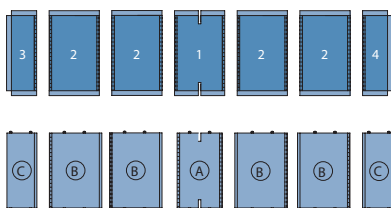

## AM5160 Official Landing Mat for Rings

1 over mat & 3 under mats

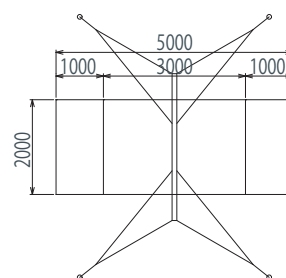
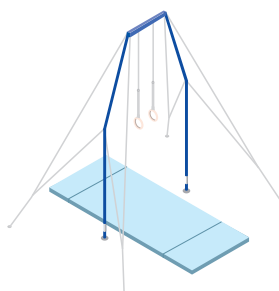
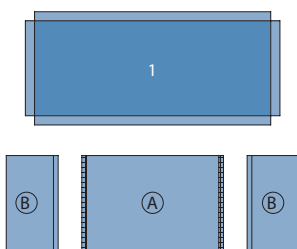

## AM5270 Official Landing Mat for Vault

4 over mat & 6 under mats

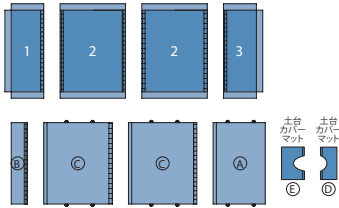

※ Include basement cover for Vault

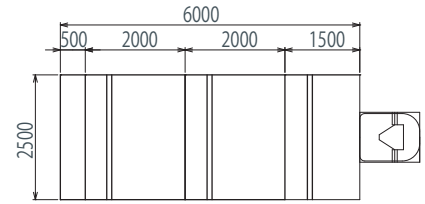
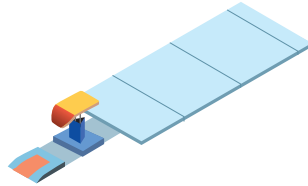

## AM5370 Official Landing Mat for Pommel Horse

2 over mats & 4 under mats

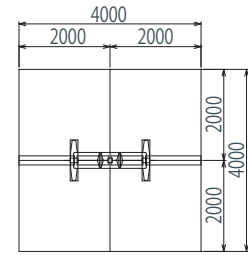
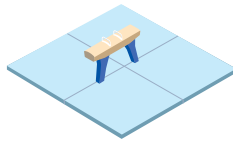
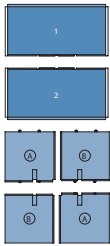

## AM5480 Official Landing Mat for Parallel Bars

5 over mat & 12 under mats

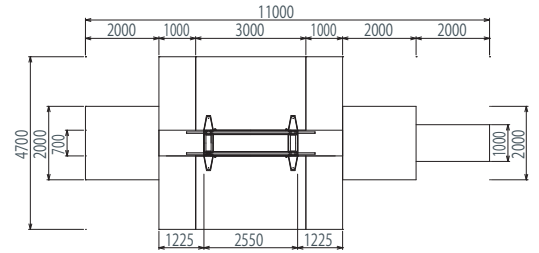
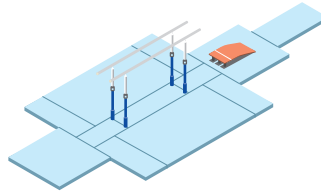
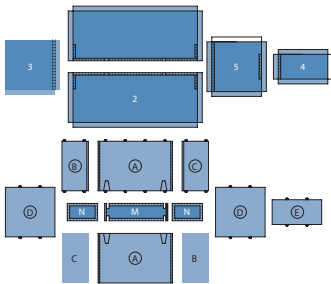

## AM5560 Official Landing Mat for Uneven Bars

5 over mat & 5 under mats

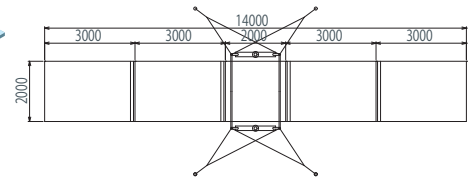
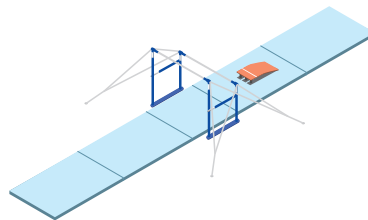
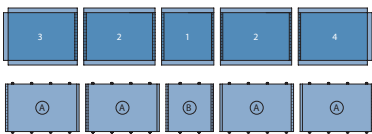

## AM5660 Official Landing Mat for Balance Beam

9 over mat & 13 under mats

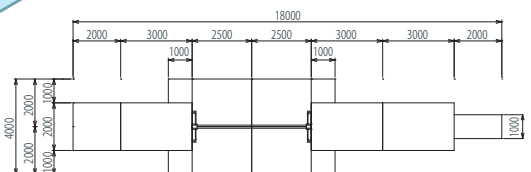
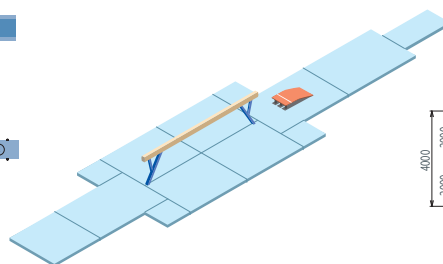
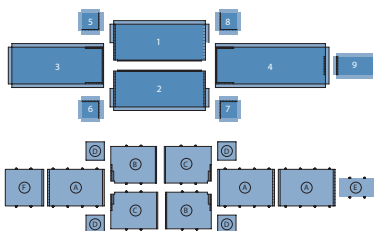

# Apparatus for Competition

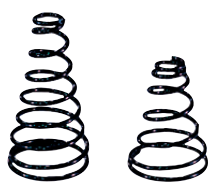

AJ070A01 Short Spring
L 120mm
AJ070A02 Long Spring
L 150mm

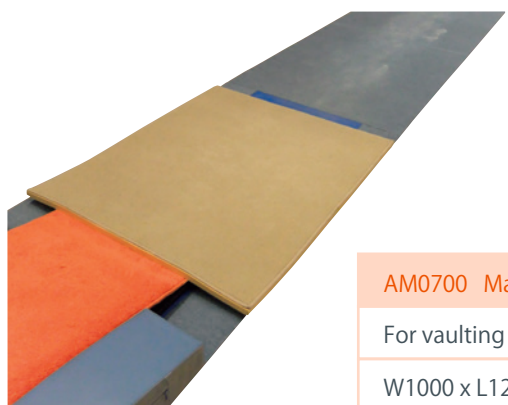

AM0700 Mat for Hands
For vaulting board
W1000 x L1200 x T28mm

AJ0700H Official Vaulting Board "Hard"
FIG approved
H220 x L1200 x W600mm
With 8 springs positions 3-3-2
Dot of dia. 8cm can be marked as per request
AJ0700S Official Vaulting Board "Soft"
FIG approved
H220 x L1200 x W600mm
With 5 or 6 springs positions 2-1-2 or 3-1-2



AK012062 Runway
W1000mm x L27.4m x TH18mm
Cushion below carpet face
Attached with Velcro tape

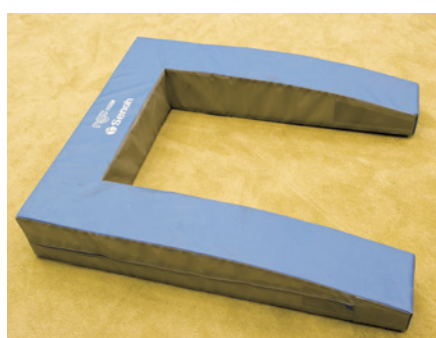

AM060762 Supplementary Mat
Additional landing mat for vaulting
W2000 x L6000 x T100mm

AT911582 Safety Collar
For vaulting board protection
W1015 x L1200 x T210mm



AM060XXX Supplementary Mat
Additional landing mat for vaulting
AM060062 : W2 x L2m x TH100mm
AM060162 : W2 x L2m x TH50mm
AM060262 : W2 x L4m x TH100mm

AM720M30 Base Mat
W1000 x L1200 x H200mm



## Miscellaneous Items for Competition



AS4210 Electric Scoreboard

Rotating double face display

Body: H1900 x L890 x W580mm

Display: H570 x L890 x W170mm

Letter height: 120mm, 220mm

LED 7 segment system

Inlaid operation panel with auto-off function

Chargeable battery or AC100V

Voltage adjusted as per request

\*Japanese market only

**NEW**

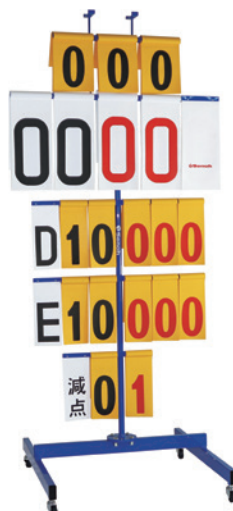

AS0700 Manual Scoreboard

Flap type

H2090 x W960mm



AS0600 D. E. Scoreboard

Indicates D and E scores with deduction points

Flap type

H1700 x W780mm



AS1030 Judges Scoreboard

Book type

H210 x L265mm



AS155062 Vaulting Indicator

For vaulting men & women

Flap type

H1500 x W60mm



AT152262 Magnesia Stand

Bowl  $\phi$ 430mm

With Caster

Caster base  $\phi$ 650mm

AT9811 Magnesia

Powder type

# Equipment for Training/Practice



## AH4XX062 Tambling Floor

W2400mm x L18m

Nylon twist carpet 1pc, Middle cushion 17pcs  
Under cushion 17pcs, Elastic panel 15pcs

AH430062: spring type

AH411062: sponge type



## AF211162 Training Round Horse

Φ650 x H800mm

For Junior use

## AF210M05 Head with Pommel

Φ650mm  
(without stand)

## AF201162 Training Round Horse

Φ970 x H800mm

Detachable leg

## AF2103 Training Round Horse

Φ500 x H50mm,  
set of 3pcs

Height adjustable  
(50, 100, 150mm)

## AE130062 Training Vaulting Table

Fitted with special padding  
and uniformed cushion  
of elastic

Height adjustable  
1250 or 1350mm

L1200 x W950

Detachable leg



## AT92XX Practice Forward and Backward Roll

Urethane foam made, covered  
by tarpaulin

AT9210 S size :  
W800 x L700 x H700

AT9220 M size :  
W800 x L850 x H850

AT9230 L size :  
W800 x L1000 x H1000

## AE9200 Practice Vaulting Box

Urethane foam made, covered  
by tarpaulin

W800 x L1000 x H1250mm

Set of 4 boxes

## AJ9051 Poline Board

Spring board for vault practice

Frame: W1100 x L1500 x H380mm  
Bed: W600 x L900mm

Front height changeable  
(380, 410, 440mm)

With caster

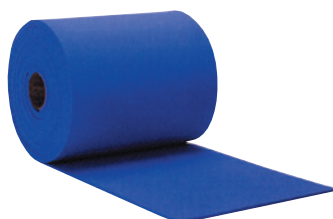

## AK9010 Runway for Training

Elastic foam made

W1000 x T20mm x L25m

## Equipment for Training /Practice

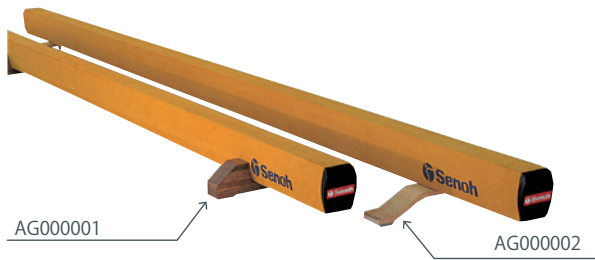

**AG000001 Beam Base**

Wooden fitted type

**AG000002 Beam Base**

Laminated wooden elastic type



**AG9350 Shock Absorption Mat**

EVA foam covered with synthetic leather

W980 x L980 x TH12mm

Multipurpose for balance beam, vault, parallel bars, and landing for hands



**AG9100 Protection Beam Pad**

EVA foam cored polyurethane covered with polyester

W110 x L1600 x TH20mm

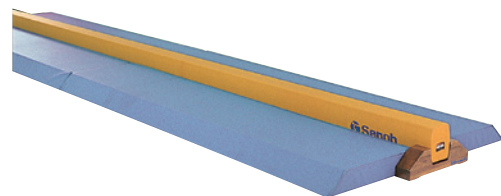

**AT910782 Low Platform Beam Set**

EVA foam cored polyethylene covered with tarpaulin

W500 x L4800 x TH100mm



**AG3100 Flat Training Beam**

W100 x L5000 x TH14.4mm

Two foldable L2500m

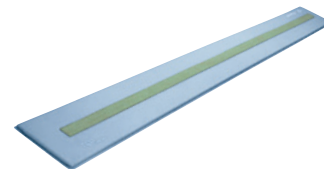

**AG920082 Training Beam Mat**

Three layered polyethylene covered with tarpaulin

Sewed with W100 x L5000 mm beam top at the center

W500 x L5400 x TH30mm



**AT9105 Platform for Balance Beam**

EVA foam cored polyethylene covered with tarpaulin

W600 x L1500 x H1040mm

Sold in pair



**AT9106 Spotting Block**

For balance beam ( multi use )

Styrene foam with EVA and EVA urethane, covered with tarpaulin

W1230 x L1830 x H550mm

## Equipment for Training/Practice



### AD910XXX Bar Pads for Parallel & Uneven Bars

AD910582 : L300mm	AD910882 : L1000mm
AD910682 : L500mm	AD910982 : L1200mm
AD910782 : L600mm	



### AT1012 Hand Standing Bars

Grip  $\Phi$ 36mm

W430 x H410 / 320mm (2 types of height)

Sold in pair



### AT1020 Hand Standing Bars

Grip  $\Phi$ 36mm

W150 x L250 x H122mm

Sold in pair



### AB2103 Training Rings

Horizontal bar suspension device

Ring H450mm at H2800mm of horizontal bar

W500mm

For hand stand and leveling position practice

Sold in pair





<b>AN905X82 Soft Mat 200</b>
Core: high density urethane Cover: polyester double knit
AN905082: W2 x L3m x TH200mm
AN905182: W1.5 x L2m x TH200mm



<b>AN905282 Soft Mat 300</b>
Shock absorption foam covered with polyester double knit
W2 x L3m x TH300mm

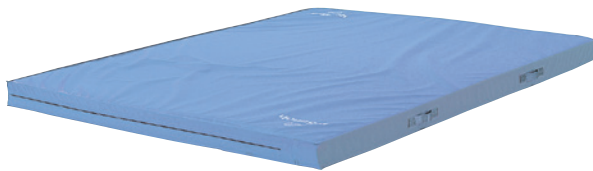

<b>AM930X82 Soft Mat 90</b>
Tarpaulin cover
AM930082: W1.5 x L2m x TH90mm
AM930182: W2 x L3m x TH90mm

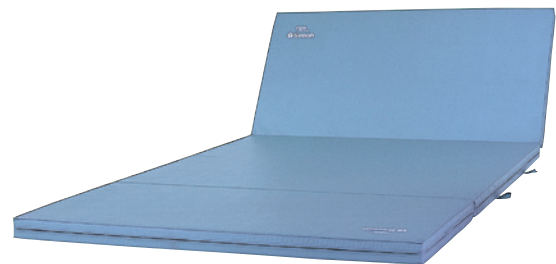

<b>AM920282 Landing Mat</b>
3 fold type
Tarpaulin cover
W2 x L4m x TH100mm

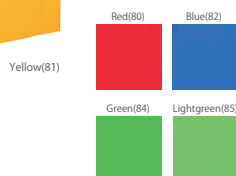

<b>AT9100 Spotting Block</b>
Styrene foam with EVA, covered with tarpaulin
W630 x L1050 x H800mm



<b>AT3200 Spotting Block</b>
Styrene foam with urethane, covered with vinyl leather
W700 x L1000 x H600mm



### AZ0400 Training Pit NGC System

Landing pit is composed with 3 layers of  
 1) high shock absorption urethane foam blocks  
 2) suspended web bed  
 3) high density urethane foam cored mat



### CA4004 Pit Trampoline

Canvas bed: W3700 x L1780mm, mesh type

Suspension: rubber cables

Frame size: W4610 x L3010mm



### AN901082 Mat for Pit

12 layered foam

W2 x L3m x TH120mm

Also usable as landing mat



### AN905382 Mat for Pit

Double knit cover

W2 x L3m x TH600mm

# Floor Apparatus & Transporter

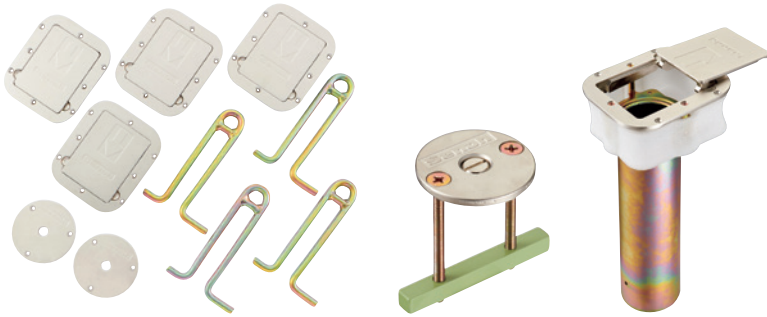

KA1541 / KA1641

KA5231

KD0241

## KXXXX Floor Apparatus

Aluminum alloy made

KA1541: for horizontal bar, rings, uneven bars

KA1641: for vault and pommel horse

KA5231: for parallel bars

KD0241: for low horizontal bar



## AP011062 Transporter for Parallel Bars

L1130 x H800mm



## AP022162

Transporter for Beam / Pommel Horse / Vault

sold in pair

**NEW**

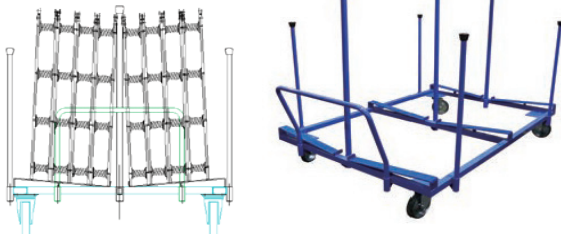

## AH041100 Transporter for Floor Panels

W1625 x L2500 x H1670mm

Spring panels: 5 carts  
Rhythmic panels: 2 carts



## AP032062 Apparatus Storage Truck

Horizontal, Rings, Uneven are storable in 1 truck

With hook cap

W1050 x L1000 x H1310mm

Color: blue

**NEW**



## AP1020 Cart

W934 x L1500 x H850mm

## AP1130 Cart

W1240 x L2050 x H850mm

**NEW**



## AH040005 Multi Transporter

W500 x L900 x H160mm

Sold in pair



### AL103X Vaulting Box

8 stepped boxes with elastic padding covered with canvas

AL1030: W1050 x L1200 x H1350mm

AL1031: W900 x L1000 x H1200mm

AL1032: W800 x L800 x H1000mm



### AT9600 Fitted Mat for Vaulting Box

Double layer polyurethane cored, covered by vinyl canvas

W2000 x L2000 x TH100mm



### AJ0512 Double Flex Springboard

W600 x L1200 x H234mm

Special elastic curved plywood, covered with non-slip turf carpet overlay

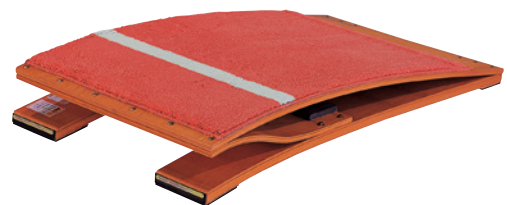

### AJ2330 Double Flex Springboard

W600 x L1200 x H175mm

For junior high school education



### AJ9020 Educational Springboard

W550 x L1000 x H200mm

For elementary school education



### AJ9010 Educational Springboard

W600 x L650 x H130mm

For kids use



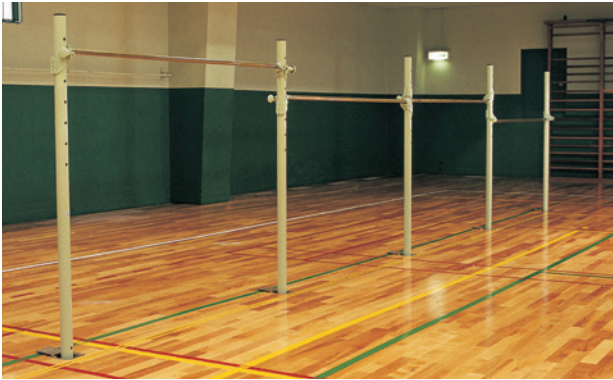

## AA200SXX Low Horizontal Bar

Upright:  $\Phi$ 60.5mm

Bar:  $\Phi$ 28mm ( cold finished steel )

W2000 x H1000-1500mm

Under floor 250mm



## AN013X Soft Mat

Urethane foam cored, covered with tetrone canvas

With air vents and handles at side

AN0130 : 2 x 3m, TH200mm

AN0131 : 2 x 3m, TH300mm

AN0132 : 2 x 3m, TH400mm



## AM22XX Senoh Mat White

Molded synthetic sponge mat

AM2200: W1.2 x L3m x TH60mm

AM2201: W1.2 x L6m x TH60mm

AM2202: W1.5 x L3m x TH60mm

AM2203: W1.5 x L6m x TH60mm

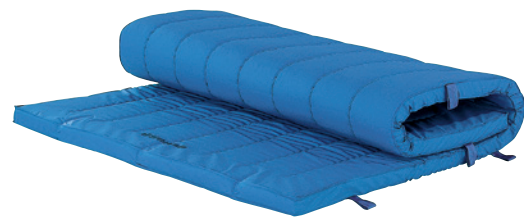

## AM14XX Senoh Mat Blue

Molded synthetic sponge mat

AM1400: W1.2 x L3m x TH60mm

AM1401: W1.2 x L6m x TH60mm

AM1402: W1.5 x L3m x TH60mm

AM1403: W1.5 x L6m x TH60mm



## AM91XX Landing Mat

Polyester canvas cover, reversible

EVA foam and high density urethane

AM9100: W2 X L3m x TH70mm

AM9101: W1.5 X L2m x TH70mm



# Apparatus List for Competition

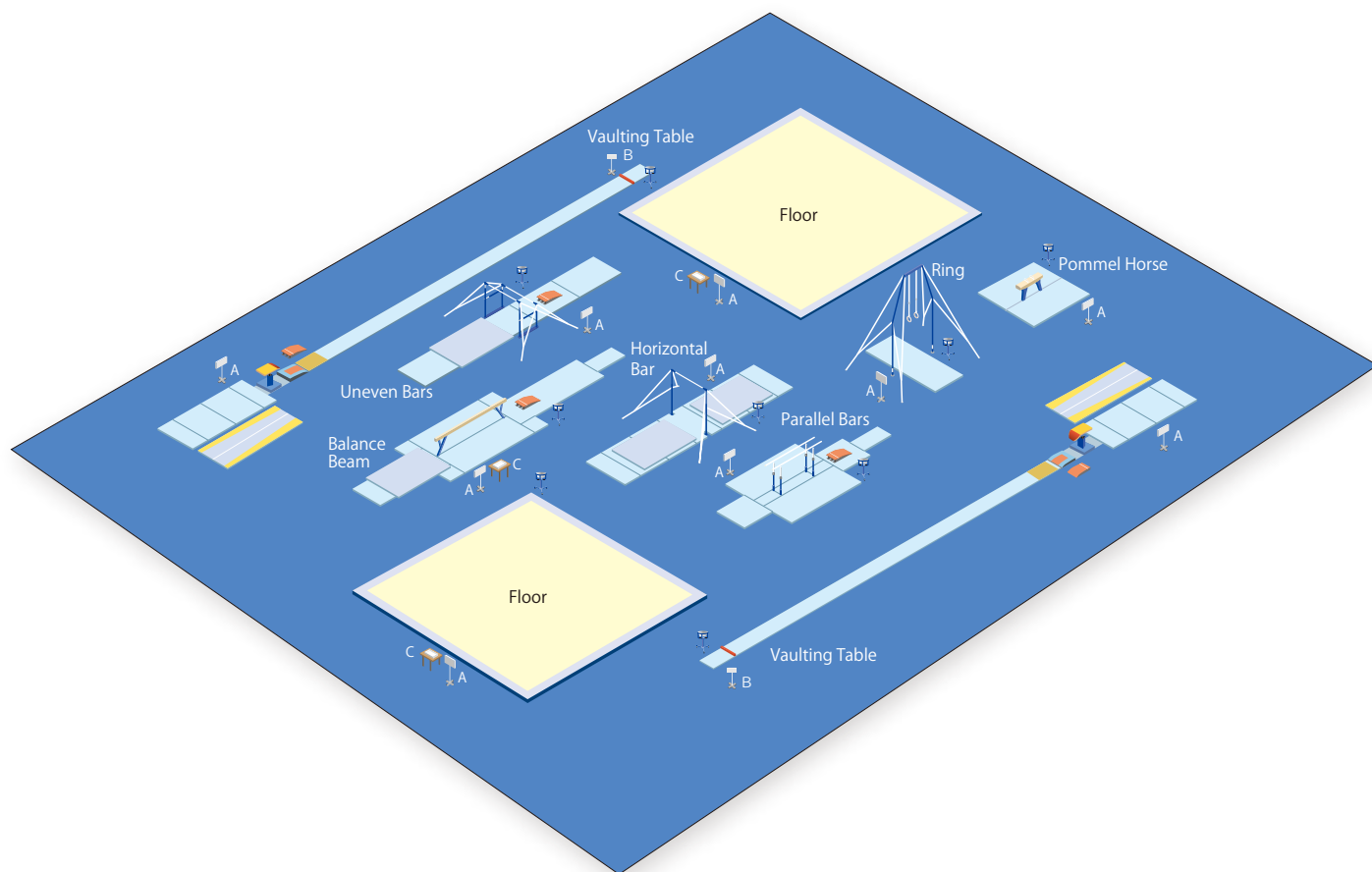

Item Code	Item	Page	QTY
AH043062	Floor	P.3	2
AF021262	Pommel Horse	P.4	1
AM5370/AM7310	Landing Mat for Pommel Horse	P.14/12	1
AB0320	Rings	P.5	1
AM5160/AM7110	Landing Mat for Rings	P.13/11	1
AE0500	Vault	P.6	2
AM5260/AM7220	Landing Mat for Vault	P.14/12	2
AM060762	Supplementary Mat for Vault	P.15	2
AJ0700	Vaulting Board	P.15	4
AK012062	Runway for Vault	P.15	2
AT911582	Rondat Mat	P.15	2
AM0700	Mat for Hands	P.15	2
AC0200	Parallel Bars	P.7	1
AM5480/AM7410	Landing Mat for Parallel Bars	P.14/12	1
AJ0700	Vaulting Board	P.15	1
AC052062	Horizontal Bar	P.8	1
AM5060/AM7010	Landing Mat for Horizontal Bar	P.13/11	1
AM060262	Supplementary Mat	P.16	1
AD012262	Uneven Bars	P.9	1
AM5560/AM7510	Landing Mat for Uneven Bar	P.14/12	1
AM060262	Supplementary Mat	P.15	1
AJ0700	Vaulting Board	P.15	1
AG013162	Balance Beam	P.10	1
AM5660/AM7610	Landing Mat for Balance Beam	P.14/12	1
AM060262	Supplementary Mat	P.15	1
AJ0700	Vaulting Board	P.15	1

Item Code	Item	Page	QTY
AS4210	Scoreboard	A P.16	10
AS056062	Scoreboard	A P.16	10
AS0600	Scoreboard	A P.16	10
AS155062	Vaulting Indicator	B P.16	2
AS4000	Timer with Buzzer for Floor	C P.16	2
AS4001	Timer with Buzzer for Balance Beam	C P.16	1
AT152262	Magnesia Stand	P.16	10

	Height from floor	
	Pommel Horse	1150mm
	Rings	2800mm
men	Vault	1350mm
	Parallel Bars	2000mm
	Horizontal Bar	2800mm
	Uneven Bars	1700mm, 2500mm
women	Balance Beam	1250mm
	Vault	1250mm

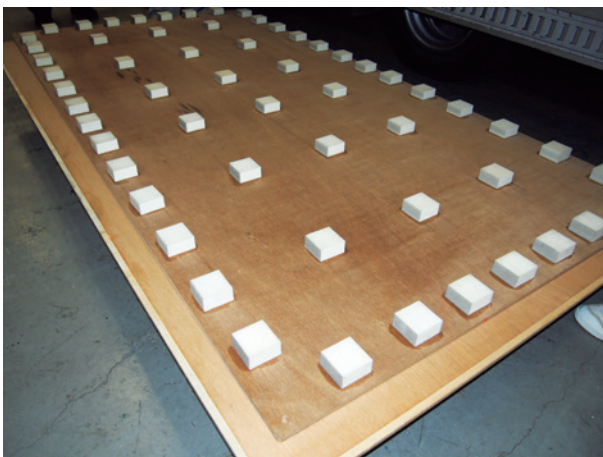
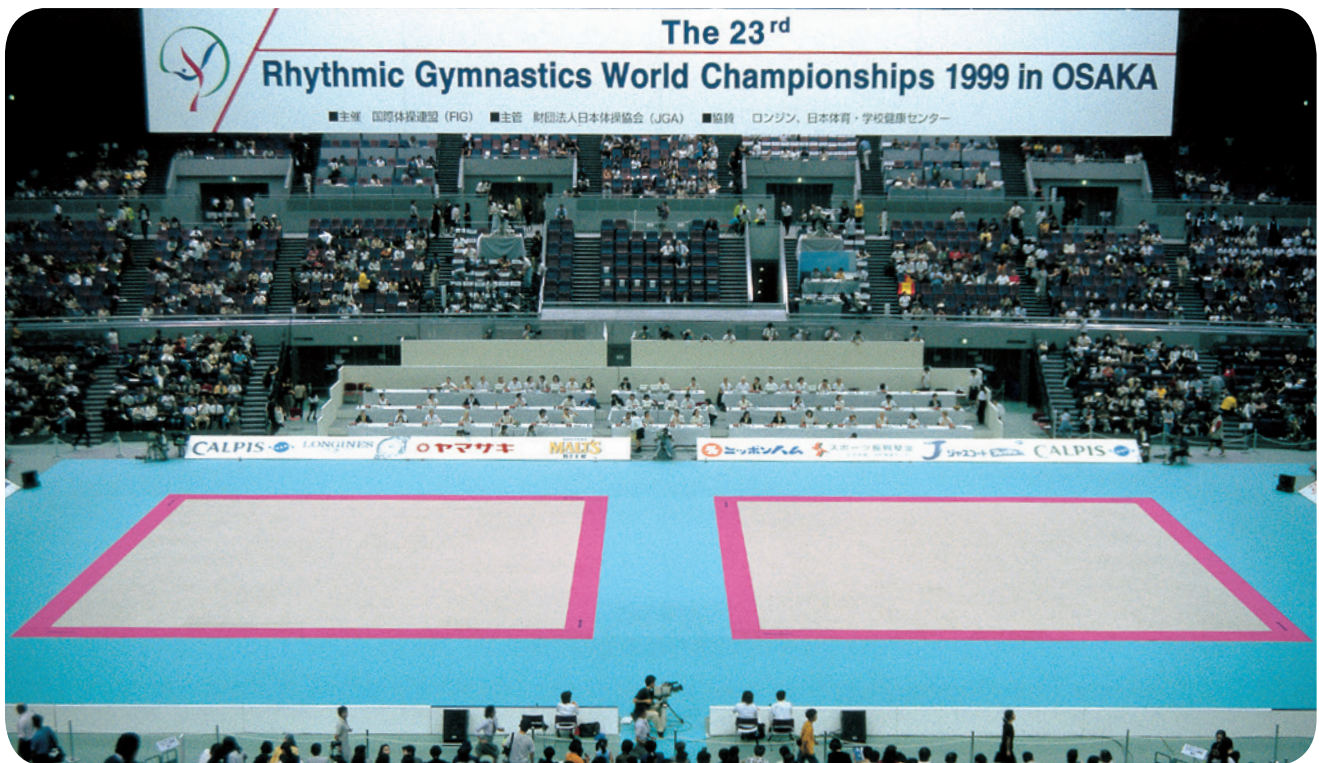

### AH0651 Official Rhythmic Gymnastics Floor

FIG approved

Carpet face with nylon tuft overlay  
 4000 x 14500 x TH8mm, 2pcs  
 3250 x 14500 x TH8mm, 2pcs

EVA foam under cushion  
 2000 x 14000 x TH5mm, 7 rolls

Intensified elastic sponge panel  
 2334 x 1167 x TH42mm, 72pcs

# Trampoline

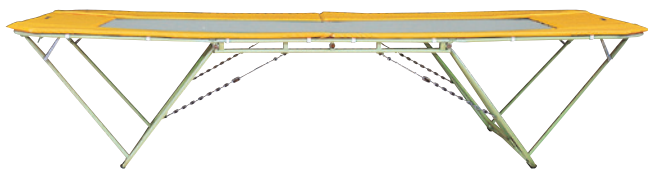

## CA2011 Regulation Trampoline

Mesh bed: 3700 x 1780mm

Suspension: rubber cables 100pcs

Frame size: W2750 x L4600 x H1000mm

Folding size: W810 x L2970 x H1985mm

User's weight limit: 80kg

## CA2111 Regulation Trampoline

CA2011 with supplemental frame

Frame size: W3000 x L4600 x H1000mm

Folding size: W810 x L3050 x H1985mm

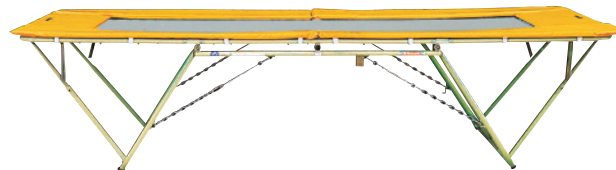

## CA6011 Little Giant Trampoline

For educational use

Mesh bed: 2910 x 1470mm

Suspension: rubber cables 78pcs

Frame size: W2260 x L3630 x H860mm

Folding size: W810 x L2400 x H1690mm

User's weight limit: 60kg



## CB1000 Sportsman Trampoline

Use for small children

Canvas bed: 1700x 1125mm

Suspension: rubber cables

Frame size: W1690 x L2150 x H600mm

With cart

User's weight limit: 30kg



## CR0100 Soft Trampoline

Use for small children and the challenged persons

Mesh bed: 2910 x 1470mm

Suspension: rubber cables 78pcs

Frame size: W2220x L3660 x H600mm

Folding size: W1020 x L2500 x H1320mm

User's weight limit: 120kg



## AT0630 Mini Trampoline

Canvas bed: 650 x 710mm

Suspension: rubber cables

Frame size: W1140 x L1140

Angle adjust 3" or 10"

User's weight limit: 80kg

## CE111062 Spotter Mat

2 layer urethane padding covered with tetoron canvas

W1000 x L1700 x H120mm



**SENOH Corporation**

250 Matsuhidai, Matsudo-shi, Chiba 270-2214, Japan

TEL : 81-47-386-5807      Email : intl-1@senoh.co.jp

<https://www.senoh.jp>

---